

Composite dry sliding bushings, metric dimensions

Principal dimensions			Basic load ratings		Mass	Designation
d	D	B	dynamic C	static C0	kg	-
mm			kN			
<b>45</b>	50	50	176	550	0,14	PCM 455050 E

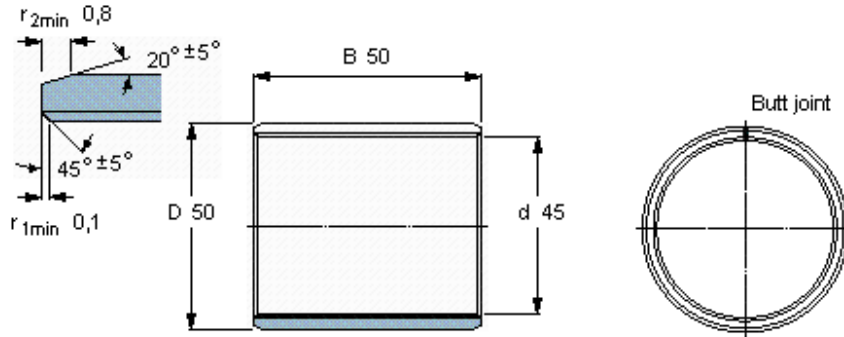

<b>Specific load factor</b>	K 80
<b>Material constant</b>	$K_M$ 480